

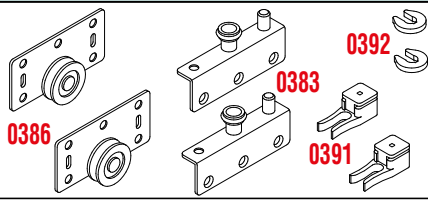



KIT 0383-386 - MAX 50 KG



Legenda KIT / Kit Legend

0386	Carrello inferiore con cuscinetto Ø30 <i>Lower truck with ball bearing Ø30</i>
0383	Guida superiore DX-SX <i>Right-left upper runner</i>
0391	Fermo superiore <i>Upper stopper</i>
0392	Antisganciamento per guida Art.0383 <i>Clasp for runner Art.0383</i>

Legenda altri componenti Legend other items

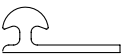
0390		Profilo alluminio superiore <i>Upper aluminium profile</i>
0380		Profilo alluminio inferiore <i>Lower aluminium profile</i>
0300		Profilo alluminio inferiore <i>Lower aluminium profile</i>

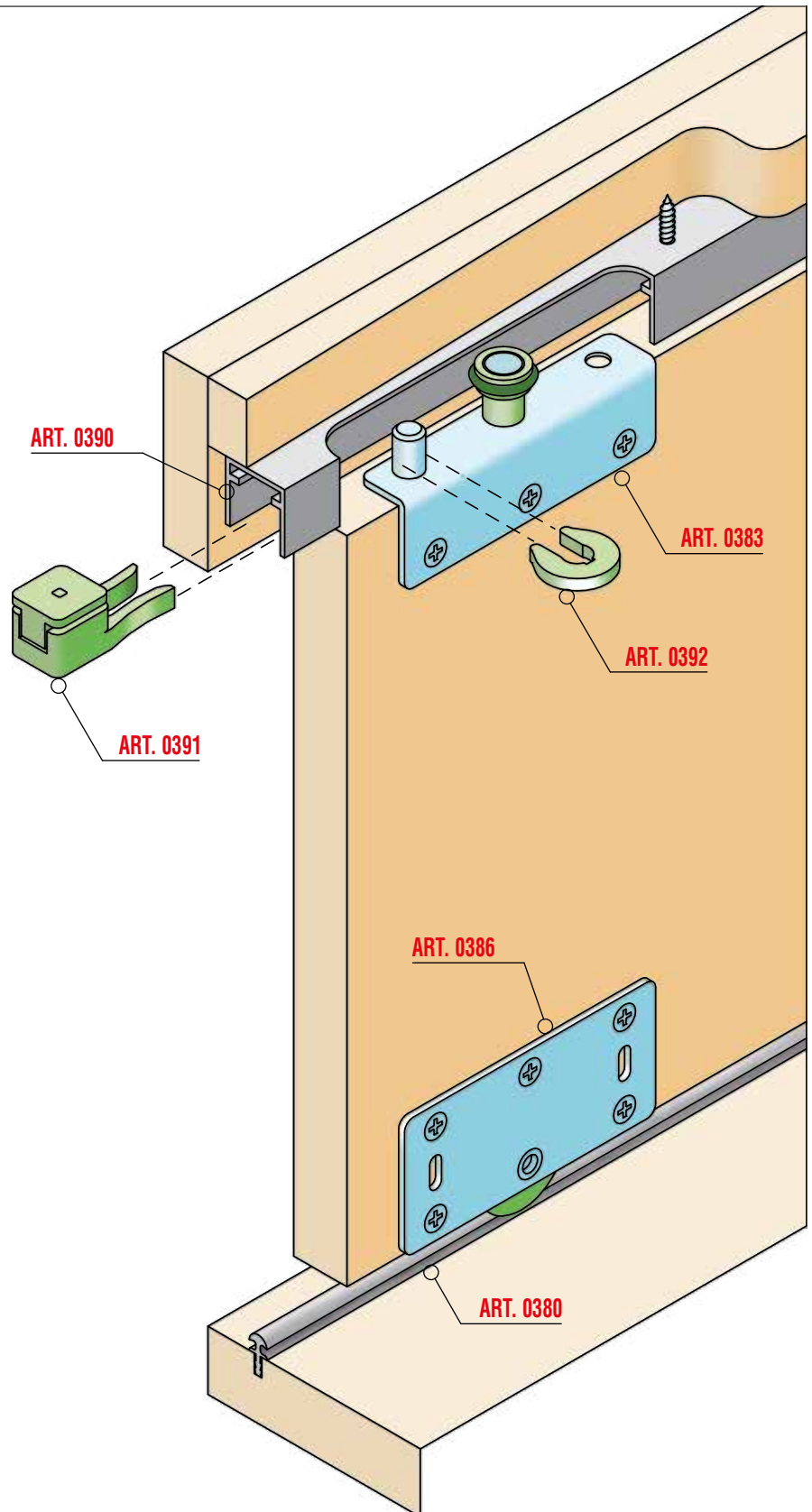



Sezione verticale / Vertical section

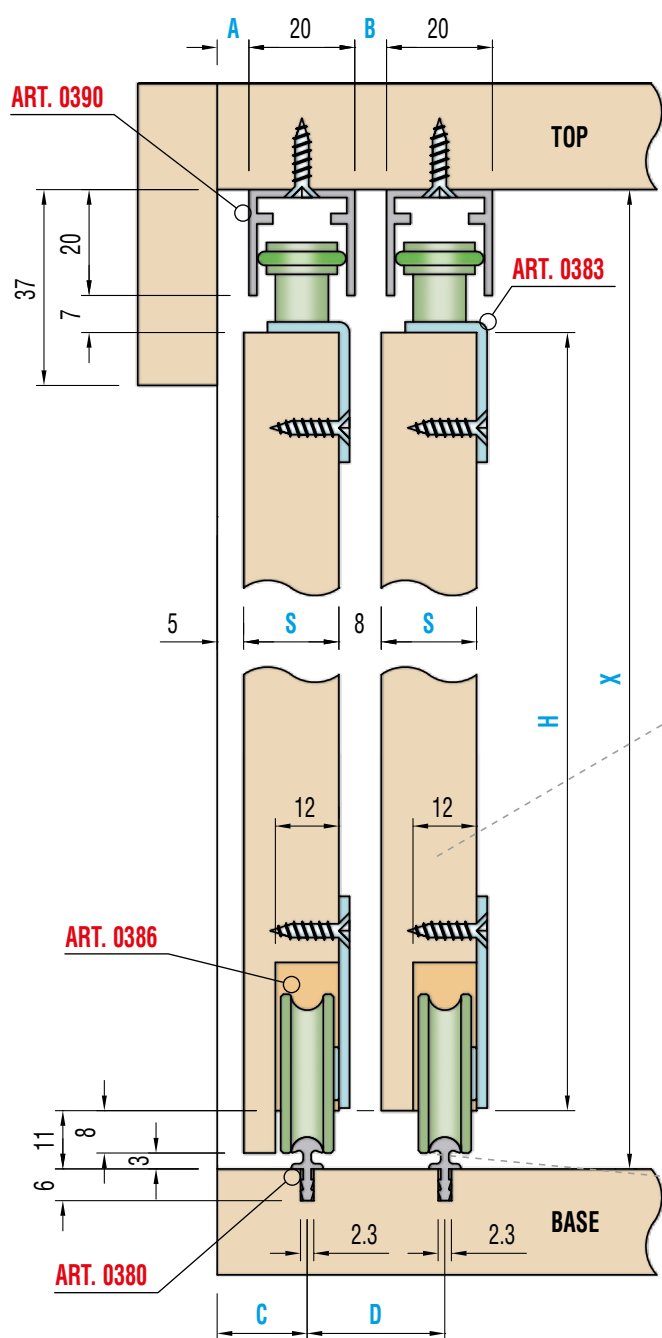

Peso massimo anta Kg. 50
Maximum door weight Kg 50

A =	S* -12
B =	S* -12
C =	S* -1
D =	S* +8
H =	X -38

S* (spessore / thickness)
min.16

**Variante
Special version**

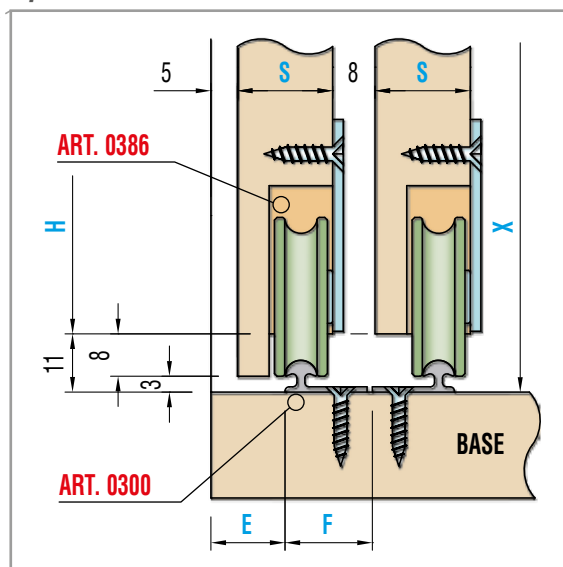

E =	S* -4
F =	S* -1,5
H =	X -38

Schema Foratura ante / Doors drilling

